

McAlester Invitational

106

| POOL A | | Round 1 | Round 2 | Round 3 | Round 4 | Round 5 |
|--------|------------------------------|--|---|---|--|--|
| 1 | Dylan Fisher Ada, 7-0, &n | 2 /_ Bout 1 Fisher, Ada Bye | 3 /_ Bout 7 Fisher, Ada Fall 0:00 | 4 /_ Bout 13 Fisher, Ada MD 11-0 | 5 /_ Bout 19 Fisher, Ada Fall 0:00 | 6 /_ Bout 25 Fisher, Ada Fall 0:00 |
| 2 | Bye | 1 /_ Bout 1 Fisher, Ada Bye | 5 /_ Bout 8 Chester, Pot Bye | 6 /_ Bout 14 Hewitt, VB Bye | 4 /_ Bout 20 Case, Ard Bye | 3 /_ Bout 26 Page, Mus Bye |
| 3 | Zack Page Mus, 0-4, &n | 4 /_ Bout 2 Case, Ard Fall 0:24 | 1 /_ Bout 7 Fisher, Ada Fall 0:00 | 5 /_ Bout 15 Chester, Pot Fall 0:00 | 6 /_ Bout 21 Hewitt, VB Fall 0:00 | 2 /_ Bout 26 Page, Mus Bye |
| 4 | Michael Case Ard, 5-2, &n | 3 /_ Bout 2 Case, Ard Fall 0:24 | 6 /_ Bout 9 Case, Ard Fall 0:00 | 1 /_ Bout 13 Fisher, Ada MD 11-0 | 2 /_ Bout 20 Case, Ard Bye | 5 /_ Bout 27 Case, Ard Fall 0:00 |
| 5 | John Chester Pot, 4-4, &n | 6 /_ Bout 3 Chester, Pot Fall 1:21 | 2 /_ Bout 8 Chester, Pot Bye | 3 /_ Bout 15 Chester, Pot Fall 0:00 | 1 /_ Bout 19 Fisher, Ada Fall 0:00 | 4 /_ Bout 27 Case, Ard Fall 0:00 |
| 6 | Dillon Hewitt VB, 2-6, &n | 5 /_ Bout 3 Chester, Pot Fall 1:21 | 4 /_ Bout 9 Case, Ard Fall 0:00 | 2 /_ Bout 14 Hewitt, VB Bye | 3 /_ Bout 21 Hewitt, VB Fall 0:00 | 1 /_ Bout 25 Fisher, Ada Fall 0:00 |

| POOL B | | Round 1 | Round 2 | Round 3 | Round 4 | Round 5 |
|--------|----------------------------------|--|---|--|--|--|
| 1 | Emma Alexander McA, 0-6, &n | 2 /_ Bout 4 Alexander, McA Bye | 3 /_ Bout 10 Alexander, McA Bye | 4 /_ Bout 16 Pennington, Gro Fall 0:00 | 5 /_ Bout 22 Brown, Dur Dec 7-2 | 6 /_ Bout 28 Moulton, Jay Fall 0:00 |
| 2 | Bye | 1 /_ Bout 4 Alexander, McA Bye | 5 /_ Bout 11 Brown, Dur Bye | 6 /_ Bout 17 Moulton, Jay Bye | 4 /_ Bout 23 Pennington, Gro Bye | 3 /_ Bout 29 Bye Bye |
| 3 | Bye | 4 /_ Bout 5 Pennington, Gro Bye | 1 /_ Bout 10 Alexander, McA Bye | 5 /_ Bout 18 Brown, Dur Bye | 6 /_ Bout 24 Moulton, Jay Bye | 2 /_ Bout 29 Bye Bye |
| 4 | Haven Pennington Gro, 4-3, &n | 3 /_ Bout 5 Pennington, Gro Bye | 6 /_ Bout 12 Moulton, Jay MD 15-6 | 1 /_ Bout 16 Pennington, Gro Fall 0:00 | 2 /_ Bout 23 Pennington, Gro Bye | 5 /_ Bout 30 Pennington, Gro Fall 0:00 |
| 5 | Spur Brown Dur, 2-4, &n | 6 /_ Bout 6 Moulton, Jay Fall 0:25 | 2 /_ Bout 11 Brown, Dur Bye | 3 /_ Bout 18 Brown, Dur Bye | 1 /_ Bout 22 Brown, Dur Dec 7-2 | 4 /_ Bout 30 Pennington, Gro Fall 0:00 |
| 6 | Lewis Moulton Jay, 6-1, &n | 5 /_ Bout 6 Moulton, Jay Fall 0:25 | 4 /_ Bout 12 Moulton, Jay MD 15-6 | 2 /_ Bout 17 Moulton, Jay Bye | 3 /_ Bout 24 Moulton, Jay Bye | 1 /_ Bout 28 Moulton, Jay Fall 0:00 |

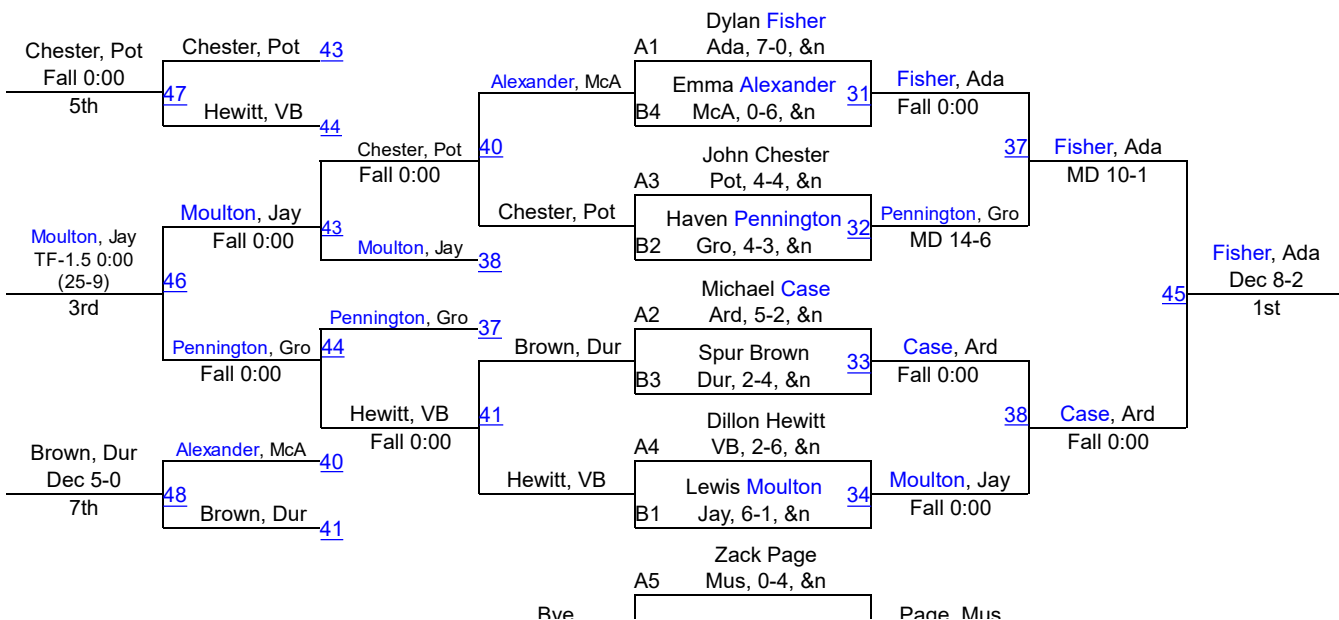

McAlester Invitational

113

| POOL A | | Round 1 | Round 2 | Round 3 | Round 4 | Round 5 |
|--------|---|---|---|---|--|--|
| 1 | Carter Patterson Ada, 8-1, &n | 2 /_ Bout <u>1</u> Patterson , Ada Fall 1:03 | 3 /_ Bout <u>7</u> Patterson , Ada Fall 0:00 | 4 /_ Bout <u>13</u> Patterson , Ada Dec 12-9 | 5 /_ Bout <u>19</u> Patterson , Ada Fall 0:00 | 6 /_ Bout <u>25</u> Patterson , Ada Dec 5-2 |
| 2 | Trenton Meadows Unat, 1-6, &n | 1 /_ Bout <u>1</u> Patterson , Ada Fall 1:03 | 5 /_ Bout <u>8</u> Hayes , VB Fall 0:00 | 6 /_ Bout <u>14</u> Terry, Pot Fall 0:00 | 4 /_ Bout <u>20</u> Delcid, Unat TF-1.5 0:00 (15-0) | 3 /_ Bout <u>26</u> Robinson, Ard Fall 0:00 |
| 3 | Thaddeus Robinson Ard, 3-4, &n | 4 /_ Bout <u>2</u> Delcid, Unat Fall 2:39 | 1 /_ Bout <u>7</u> Patterson , Ada Fall 0:00 | 5 /_ Bout <u>15</u> Hayes , VB Fall 0:00 | 6 /_ Bout <u>21</u> Terry, Pot Fall 0:00 | 2 /_ Bout <u>26</u> Robinson, Ard Fall 0:00 |
| 4 | Johnathan Delcid Unat, 5-4, &n | 3 /_ Bout <u>2</u> Delcid, Unat Fall 2:39 | 6 /_ Bout <u>9</u> Terry, Pot Dec 10-5 | 1 /_ Bout <u>13</u> Patterson , Ada Dec 12-9 | 2 /_ Bout <u>20</u> Delcid, Unat TF-1.5 0:00 (15-0) | 5 /_ Bout <u>27</u> Delcid, Unat Fall 0:00 |
| 5 | Mason Hayes VB, 3-6, &n | 6 /_ Bout <u>3</u> Terry, Pot Dec 11-4 | 2 /_ Bout <u>8</u> Hayes , VB Fall 0:00 | 3 /_ Bout <u>15</u> Hayes , VB Fall 0:00 | 1 /_ Bout <u>19</u> Patterson , Ada Fall 0:00 | 4 /_ Bout <u>27</u> Delcid, Unat Fall 0:00 |
| 6 | Bryson Terry Pot, 6-3, &n | 5 /_ Bout <u>3</u> Terry, Pot Dec 11-4 | 4 /_ Bout <u>9</u> Terry, Pot Dec 10-5 | 2 /_ Bout <u>14</u> Terry, Pot Fall 0:00 | 3 /_ Bout <u>21</u> Terry, Pot Fall 0:00 | 1 /_ Bout <u>25</u> Patterson , Ada Dec 5-2 |

| POOL B | | Round 1 | Round 2 | Round 3 | Round 4 | Round 5 |
|--------|--------------------------------------|---|--|--|--|--|
| 1 | Lane Maggard Unat, 2-5, &n | 2 /_ Bout <u>4</u> Wyatt , Gro Fall 0:37 | 3 /_ Bout <u>10</u> Orlando, Dur Fall 0:00 | 4 /_ Bout <u>16</u> Tillman , Mus Fall 0:00 | 5 /_ Bout <u>22</u> Maggard , Unat Fall 0:00 | 6 /_ Bout <u>28</u> Nohelty , McA Fall 0:00 |
| 2 | Caiden Wyatt Gro, 3-5, &n | 1 /_ Bout <u>4</u> Wyatt , Gro Fall 0:37 | 5 /_ Bout <u>11</u> Wyatt , Gro Fall 0:00 | 6 /_ Bout <u>17</u> Nohelty , McA Fall 0:00 | 4 /_ Bout <u>23</u> Tillman , Mus Fall 0:00 | 3 /_ Bout <u>29</u> Orlando, Dur Fall 0:00 |
| 3 | Caden Orlando Dur, 3-5, &n | 4 /_ Bout <u>5</u> Tillman , Mus TF-1.5 0:00 (19-2) | 1 /_ Bout <u>10</u> Orlando, Dur Fall 0:00 | 5 /_ Bout <u>18</u> Orlando, Dur Fall 0:00 | 6 /_ Bout <u>24</u> Nohelty , McA TF-1.5 0:00 (15-0) | 2 /_ Bout <u>29</u> Orlando, Dur Fall 0:00 |
| 4 | Shawn Tillman Mus, 7-1, &n | 3 /_ Bout <u>5</u> Tillman , Mus TF-1.5 0:00 (19-2) | 6 /_ Bout <u>12</u> Tillman , Mus Fall 0:00 | 1 /_ Bout <u>16</u> Tillman , Mus Fall 0:00 | 2 /_ Bout <u>23</u> Tillman , Mus Fall 0:00 | 5 /_ Bout <u>30</u> Tillman , Mus Fall 0:00 |
| 5 | Gage Williams BMG, 0-7, &n | 6 /_ Bout <u>6</u> Nohelty , McA Fall 0:49 | 2 /_ Bout <u>11</u> Wyatt , Gro Fall 0:00 | 3 /_ Bout <u>18</u> Orlando, Dur Fall 0:00 | 1 /_ Bout <u>22</u> Maggard , Unat Fall 0:00 | 4 /_ Bout <u>30</u> Tillman , Mus Fall 0:00 |
| 6 | Ty Nohelty McA, 7-1, &n | 5 /_ Bout <u>6</u> Nohelty , McA Fall 0:49 | 4 /_ Bout <u>12</u> Tillman , Mus Fall 0:00 | 2 /_ Bout <u>17</u> Nohelty , McA Fall 0:00 | 3 /_ Bout <u>24</u> Nohelty , McA TF-1.5 0:00 (15-0) | 1 /_ Bout <u>28</u> Nohelty , McA Fall 0:00 |

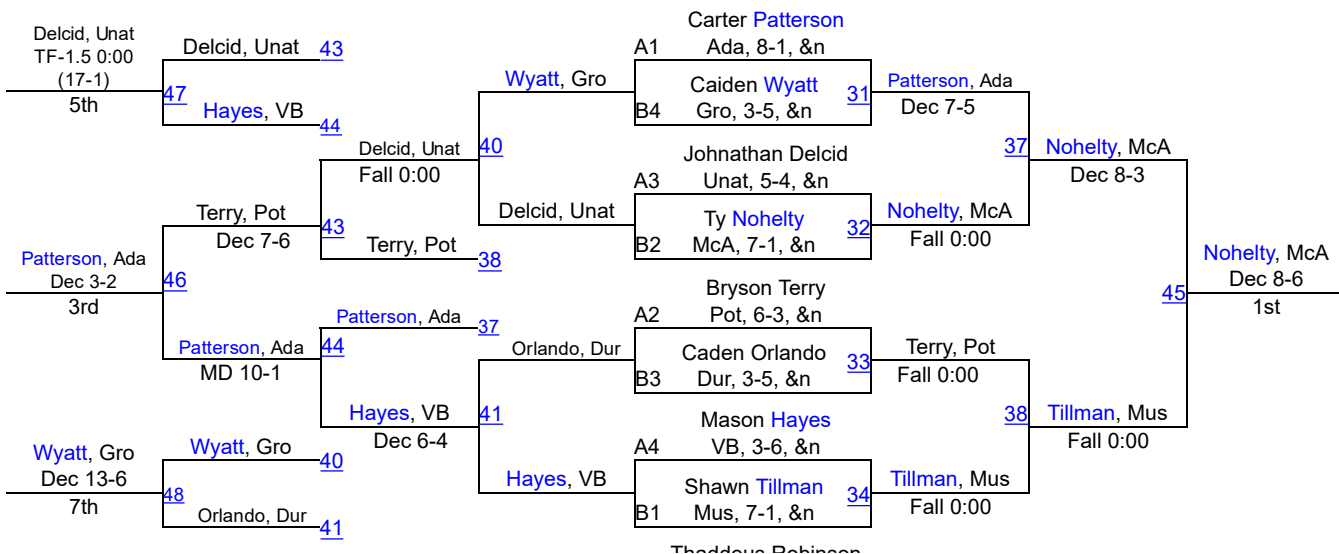

McAlester Invitational

120

| POOL A | | Round 1 | Round 2 | Round 3 | Round 4 | Round 5 |
|--------|----------------------------------|--|--|--|---|---|
| 1 | Ethan Arnold MN, 1-6, &n | 2 /_ Bout 1 Arnold, MN Bye | 3 /_ Bout 7 Arnold, MN Fall 0:00 | 4 /_ Bout 13 Prieto, Jay Fall 0:00 | 5 /_ Bout 19 Lara, Gro Fall 0:00 | 6 /_ Bout 25 Rattan, Unat Fall 0:00 |
| 2 | Bye | 1 /_ Bout 1 Arnold, MN Bye | 5 /_ Bout 8 Lara, Gro Bye | 6 /_ Bout 14 Rattan, Unat Bye | 4 /_ Bout 20 Prieto, Jay Bye | 3 /_ Bout 26 Maldonado, Dur Bye |
| 3 | Parker Maldonado Dur, 0-5, &n | 4 /_ Bout 2 Prieto, Jay Fall 15:05 | 1 /_ Bout 7 Arnold, MN Fall 0:00 | 5 /_ Bout 15 Lara, Gro Fall 0:00 | 6 /_ Bout 21 Rattan, Unat Fall 0:00 | 2 /_ Bout 26 Maldonado, Dur Bye |
| 4 | Cameron Prieto Jay, 3-4, &n | 3 /_ Bout 2 Prieto, Jay Fall 15:05 | 6 /_ Bout 9 Rattan, Unat Dec 5-0 | 1 /_ Bout 13 Prieto, Jay Fall 0:00 | 2 /_ Bout 20 Prieto, Jay Bye | 5 /_ Bout 27 Lara, Gro Fall 0:00 |
| 5 | Pedro Lara Gro, 6-1, &n | 6 /_ Bout 3 Lara, Gro Fall 0:25 | 2 /_ Bout 8 Lara, Gro Bye | 3 /_ Bout 15 Lara, Gro Fall 0:00 | 1 /_ Bout 19 Lara, Gro Fall 0:00 | 4 /_ Bout 27 Lara, Gro Fall 0:00 |
| 6 | Matt Rattan Unat, 5-3, &n | 5 /_ Bout 3 Lara, Gro Fall 0:25 | 4 /_ Bout 9 Rattan, Unat Dec 5-0 | 2 /_ Bout 14 Rattan, Unat Bye | 3 /_ Bout 21 Rattan, Unat Fall 0:00 | 1 /_ Bout 25 Rattan, Unat Fall 0:00 |

| POOL B | | Round 1 | Round 2 | Round 3 | Round 4 | Round 5 |
|--------|------------------------------------|--|---|--|---|---|
| 1 | Hunter Greenfield Unat, 1-6, &n | 2 /_ Bout 4 Webb, Mus Fall 0:30 | 3 /_ Bout 10 Wood, Pot Fall 0:00 | 4 /_ Bout 16 Hendershot, BMG Dec 9-5 | 5 /_ Bout 22 Price, VB Dec 12-6 | 6 /_ Bout 28 Smith, McA Fall 0:00 |
| 2 | Christian Webb Mus, 5-4, &n | 1 /_ Bout 4 Webb, Mus Fall 0:30 | 5 /_ Bout 11 Webb, Mus TF-1.5 0:00 (16-0) | 6 /_ Bout 17 Smith, McA Fall 0:00 | 4 /_ Bout 23 Webb, Mus Fall 0:00 | 3 /_ Bout 29 Wood, Pot Fall 0:00 |
| 3 | Chris Wood Pot, 7-2, &n | 4 /_ Bout 5 Wood, Pot Fall 1:44 | 1 /_ Bout 10 Wood, Pot Fall 0:00 | 5 /_ Bout 18 Wood, Pot Fall 0:00 | 6 /_ Bout 24 Smith, McA Fall 0:00 | 2 /_ Bout 29 Wood, Pot Fall 0:00 |
| 4 | Noah Hendershot BMG, 2-4, &n | 3 /_ Bout 5 Wood, Pot Fall 1:44 | 6 /_ Bout 12 Smith, McA Fall 0:00 | 1 /_ Bout 16 Hendershot, BMG Dec 9-5 | 2 /_ Bout 23 Webb, Mus Fall 0:00 | 5 /_ Bout 30 Price, VB Fall 0:00 |
| 5 | Antonio Price VB, 3-6, &n | 6 /_ Bout 6 Smith, McA Fall 0:38 | 2 /_ Bout 11 Webb, Mus TF-1.5 0:00 (16-0) | 3 /_ Bout 18 Wood, Pot Fall 0:00 | 1 /_ Bout 22 Price, VB Dec 12-6 | 4 /_ Bout 30 Price, VB Fall 0:00 |
| 6 | Hunter Smith McA, 8-0, &n | 5 /_ Bout 6 Smith, McA Fall 0:38 | 4 /_ Bout 12 Smith, McA Fall 0:00 | 2 /_ Bout 17 Smith, McA Fall 0:00 | 3 /_ Bout 24 Smith, McA Fall 0:00 | 1 /_ Bout 28 Smith, McA Fall 0:00 |

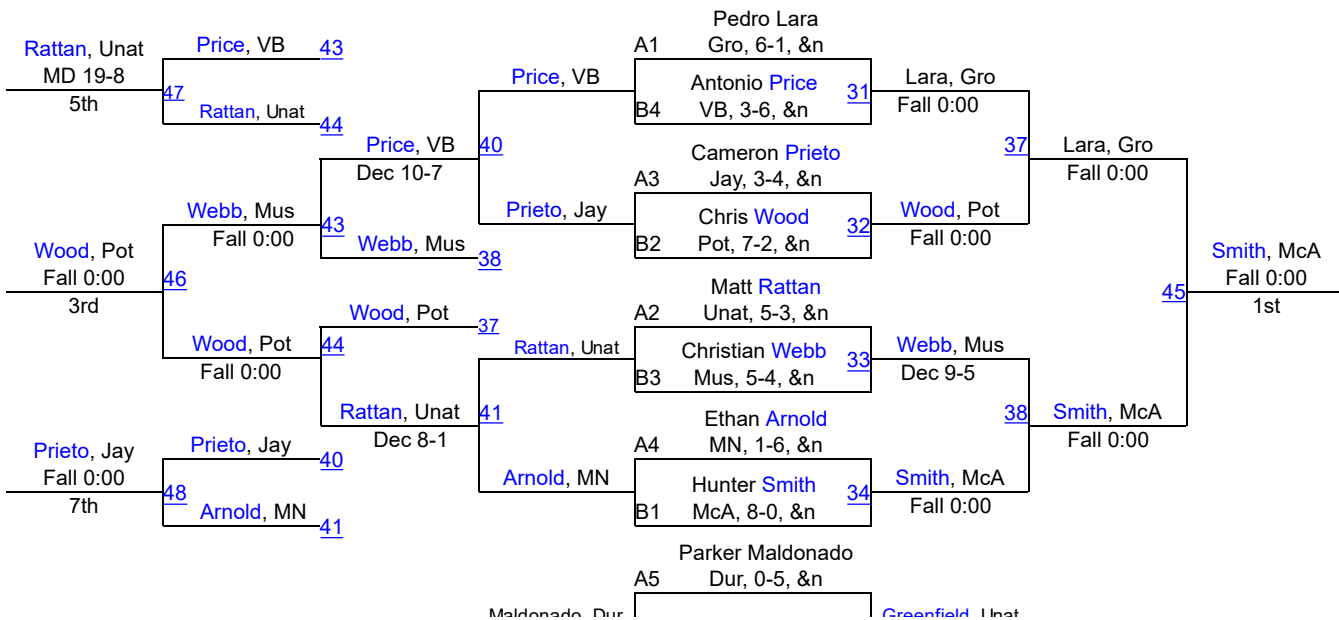

McAlester Invitational

126

| POOL A | | Round 1 | Round 2 | Round 3 | Round 4 | Round 5 |
|--------|-----------------------------------|--|--|--|---|--|
| 1 | Chase Williams VB, 3-4, &n | 2 /_ Bout 1 Williams, VB Bye | 3 /_ Bout 7 Williams, VB Fall 0:00 | 4 /_ Bout 13 Bargas, McA Fall 0:00 | 5 /_ Bout 19 Williams, VB Fall 0:00 | 6 /_ Bout 25 Carney, Unat Dec 6-4 |
| 2 | Bye | 1 /_ Bout 1 Williams, VB Bye | 5 /_ Bout 8 Pagila, MN Bye | 6 /_ Bout 14 Carney, Unat Bye | 4 /_ Bout 20 Bargas, McA Bye | 3 /_ Bout 26 Broom, Pot Bye |
| 3 | Tyler Broom Pot, 2-5, &n | 4 /_ Bout 2 Bargas, McA Fall 0:39 | 1 /_ Bout 7 Williams, VB Fall 0:00 | 5 /_ Bout 15 Broom, Pot Fall 0:00 | 6 /_ Bout 21 Broom, Pot Dec 8-2 | 2 /_ Bout 26 Broom, Pot Bye |
| 4 | Dallas Bargas McA, 6-1, &n | 3 /_ Bout 2 Bargas, McA Fall 0:39 | 6 /_ Bout 9 Bargas, McA Fall 0:00 | 1 /_ Bout 13 Bargas, McA Fall 0:00 | 2 /_ Bout 20 Bargas, McA Bye | 5 /_ Bout 27 Bargas, McA Fall 0:00 |
| 5 | JP Pagila MN, 1-5, &n | 6 /_ Bout 3 Carney, Unat Fall 0:00 | 2 /_ Bout 8 Pagila, MN Bye | 3 /_ Bout 15 Broom, Pot Fall 0:00 | 1 /_ Bout 19 Williams, VB Fall 0:00 | 4 /_ Bout 27 Bargas, McA Fall 0:00 |
| 6 | Christian Carney Unat, 3-5, &n | 5 /_ Bout 3 Carney, Unat Fall 0:00 | 4 /_ Bout 9 Bargas, McA Fall 0:00 | 2 /_ Bout 14 Carney, Unat Bye | 3 /_ Bout 21 Broom, Pot Dec 8-2 | 1 /_ Bout 25 Carney, Unat Dec 6-4 |

| POOL B | | Round 1 | Round 2 | Round 3 | Round 4 | Round 5 |
|--------|----------------------------------|--|---|--|--|--|
| 1 | Jonathan Fuller Ada, 8-0, &n | 2 /_ Bout 4 Fuller, Ada Fall 1:07 | 3 /_ Bout 10 Fuller, Ada Fall 0:00 | 4 /_ Bout 16 Fuller, Ada Fall 0:00 | 5 /_ Bout 22 Fuller, Ada Fall 0:00 | 6 /_ Bout 28 Fuller, Ada Fall 0:00 |
| 2 | Deanthony Miller Mus, 4-5, &n | 1 /_ Bout 4 Fuller, Ada Fall 1:07 | 5 /_ Bout 11 Miller, Mus TF-1.5 0:00 (17-1) | 6 /_ Bout 17 Miller, Mus Fall 0:00 | 4 /_ Bout 23 Martin, Gro Dec 10-4 | 3 /_ Bout 29 Skinner, Unat Dec 7-5 |
| 3 | Mat Skinner Unat, 5-4, &n | 4 /_ Bout 5 Martin, Gro Fall 2:17 | 1 /_ Bout 10 Fuller, Ada Fall 0:00 | 5 /_ Bout 18 Skinner, Unat Fall 0:00 | 6 /_ Bout 24 Skinner, Unat Fall 0:00 | 2 /_ Bout 29 Skinner, Unat Dec 7-5 |
| 4 | Jessie Martin Gro, 7-2, &n | 3 /_ Bout 5 Martin, Gro Fall 2:17 | 6 /_ Bout 12 Martin, Gro Fall 0:00 | 1 /_ Bout 16 Fuller, Ada Fall 0:00 | 2 /_ Bout 23 Martin, Gro Dec 10-4 | 5 /_ Bout 30 Martin, Gro Fall 0:00 |
| 5 | Shane Collier Dur, 0-6, &n | 6 /_ Bout 6 Coniglione, BMG Fall 58:03 | 2 /_ Bout 11 Miller, Mus TF-1.5 0:00 (17-1) | 3 /_ Bout 18 Skinner, Unat Fall 0:00 | 1 /_ Bout 22 Fuller, Ada Fall 0:00 | 4 /_ Bout 30 Martin, Gro Fall 0:00 |
| 6 | Jacob Coniglione BMG, 2-4, &n | 5 /_ Bout 6 Coniglione, BMG Fall 58:03 | 4 /_ Bout 12 Martin, Gro Fall 0:00 | 2 /_ Bout 17 Miller, Mus Fall 0:00 | 3 /_ Bout 24 Skinner, Unat Fall 0:00 | 1 /_ Bout 28 Fuller, Ada Fall 0:00 |

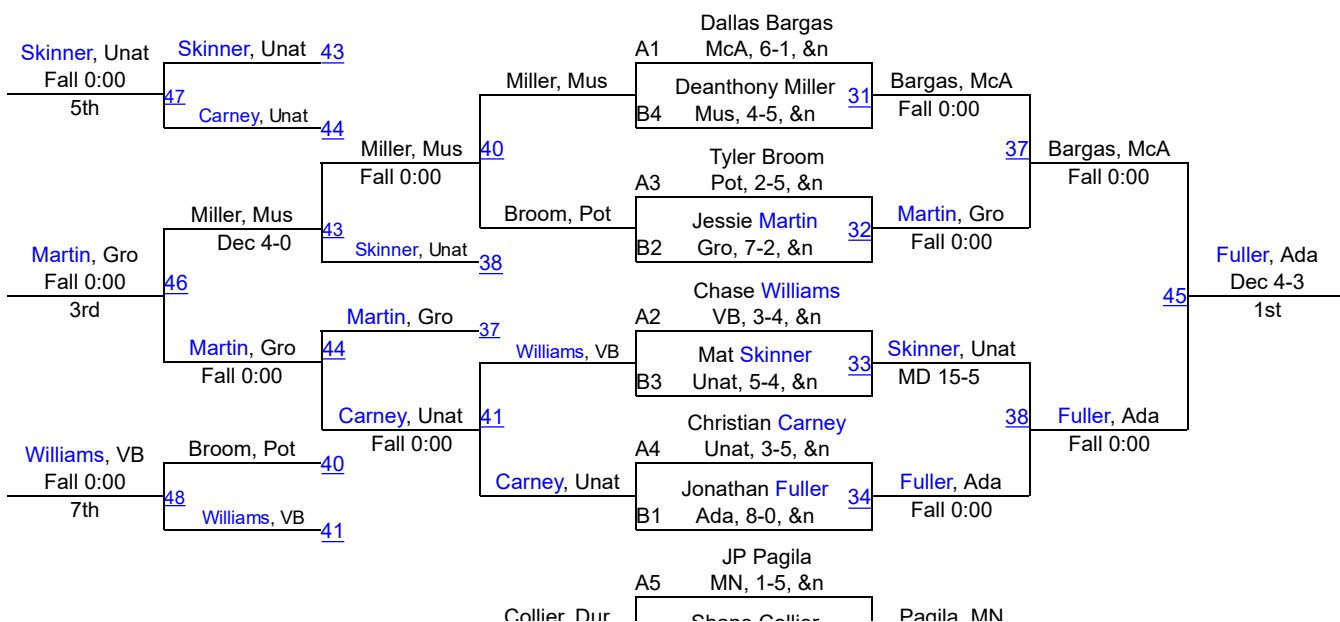

McAlester Invitational

132

Pool A

Pool B

Pool C

Pool D

ROUND 1

| |
|--------------|
| Hodge, Jay |
| 1 Hodge, Jay |
| Bye |

| |
|------------------|
| Honeycutt, Gro |
| 3 Honeycutt, Gro |
| Bye |

| |
|--------------|
| Guyer, McA |
| 5 Guyer, McA |
| Bye |

| |
|---------------|
| Taylor, Mus |
| 7 Taylor, Mus |
| Bye |

| |
|-------------------|
| Messimore, Unat |
| 2 Messimore, Unat |
| MD 11-0 |
| Snodgrass, Kin |

| |
|-----------------|
| Williams, Pot |
| 4 Williams, Pot |
| Fall 1:53 |
| Vo, BMG |

| |
|-----------|
| Le, Dur |
| 6 Le, Dur |
| Bye |

| |
|----------------|
| Meredith, MN |
| 8 Meredith, MN |
| Bye |

ROUND 2

| |
|----------------|
| Hodge, Jay |
| 9 Hodge, Jay |
| Fall 0:00 |
| Snodgrass, Kin |

| |
|-------------------|
| Honeycutt, Gro |
| 11 Honeycutt, Gro |
| Fall 0:00 |
| Vo, BMG |

| |
|---------------|
| Guyer, McA |
| 13 Guyer, McA |
| Bye |

| |
|----------------|
| Taylor, Mus |
| 15 Taylor, Mus |
| Bye |

| |
|--------------------|
| Messimore, Unat |
| 10 Messimore, Unat |
| Bye |

| |
|------------------|
| Williams, Pot |
| 12 Williams, Pot |
| Bye |

| |
|------------|
| Le, Dur |
| 14 Le, Dur |
| Bye |

| |
|-----------------|
| Meredith, MN |
| 16 Meredith, MN |
| Bye |

ROUND 3

| |
|-----------------|
| Hodge, Jay |
| 17 Hodge, Jay |
| Fall 0:00 |
| Messimore, Unat |

| |
|------------------|
| Honeycutt, Gro |
| 19 Williams, Pot |
| Fall 0:00 |
| Williams, Pot |

| |
|------------|
| Guyer, McA |
| 21 Le, Dur |
| Dec 13-10 |
| Le, Dur |

| |
|----------------|
| Taylor, Mus |
| 23 Taylor, Mus |
| Fall 0:00 |
| Meredith, MN |

| |
|-------------------|
| Snodgrass, Kin |
| 18 Snodgrass, Kin |
| Bye |
| Bye |

| |
|------------|
| Vo, BMG |
| 20 Vo, BMG |
| Bye |
| Bye |

| |
|--------|
| Bye |
| 22 Bye |
| Bye |
| Bye |

| |
|--------|
| Bye |
| 24 Bye |
| Bye |
| Bye |

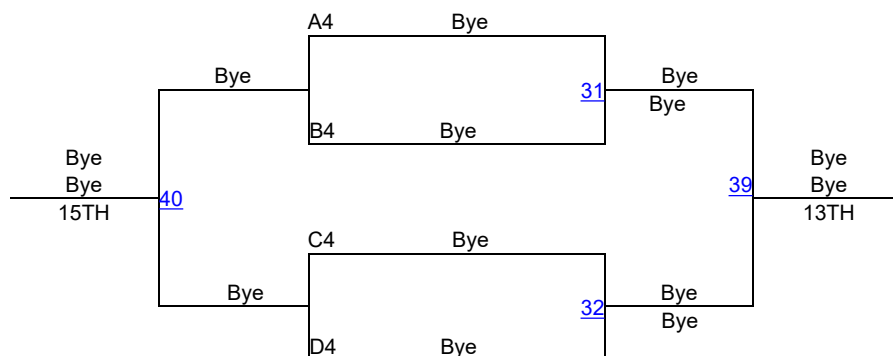
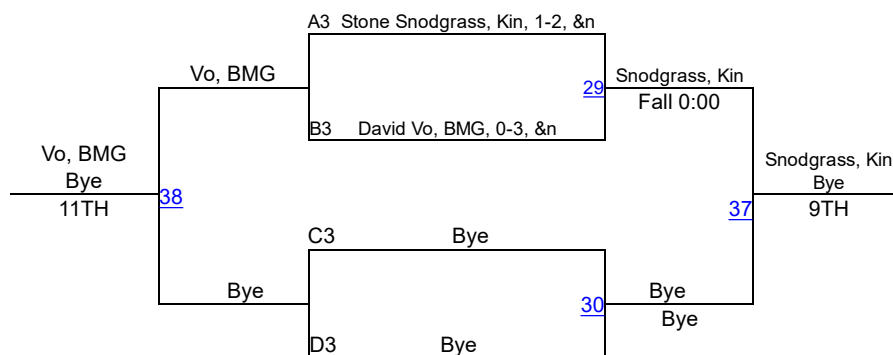
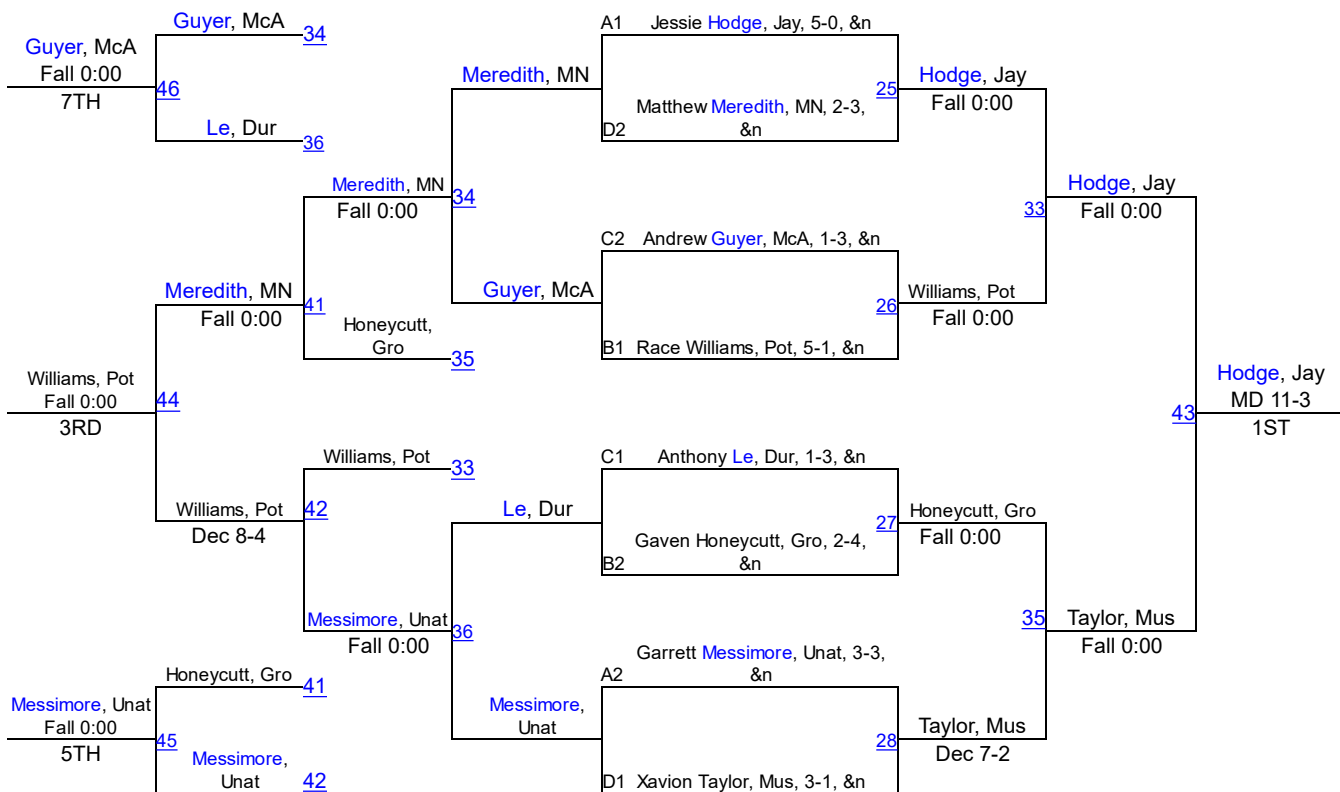

McAlester Invitational

138

Pool A

Pool B

Pool C

Pool D

ROUND 1

| |
|---------------------|
| January, Jay |
| 1 |
| January, Jay Bye |
| Bye |

| |
|-------------------|
| Daily, Pot |
| 3 |
| Daily, Pot Bye |
| Bye |

| |
|---------------------------|
| Whittingto, Dur |
| 5 |
| Whittingto, Dur Bye |
| Bye |

| |
|-----------------------|
| Kelly, McA |
| 7 |
| Kelly, McA Dec 7-3 |
| Maxwell, Mus |

| |
|------------------------|
| Noley, BMG |
| 2 |
| Goff, Ard Fall 1:08 |
| Goff, Ard |

| |
|--------------------------|
| Johnson, Jay |
| 4 |
| Riley, Unat Fall 0:47 |
| Riley, Unat |

| |
|-----------------------|
| Ruff, MN |
| 6 |
| Ruff, MN Fall 1:06 |
| Schildt, Unat |

| |
|-------------------------|
| Switzer, VB |
| 8 |
| Hardy, Gro Fall 0:39 |
| Hardy, Gro |

ROUND 2

| |
|--------------------------|
| January, Jay |
| 9 |
| January, Jay Dec 12-8 |
| Goff, Ard |

| |
|--------------------------|
| Daily, Pot |
| 11 |
| Riley, Unat Fall 0:00 |
| Riley, Unat |

| |
|---------------------------------|
| Whittingto, Dur |
| 13 |
| Whittingto, Dur Fall 0:00 |
| Schildt, Unat |

| |
|-------------------------|
| Kelly, McA |
| 15 |
| Hardy, Gro Fall 0:00 |
| Hardy, Gro |

| |
|-------------------|
| Noley, BMG |
| 10 |
| Noley, BMG Bye |
| Bye |

| |
|---------------------|
| Johnson, Jay |
| 12 |
| Johnson, Jay Bye |
| Bye |

| |
|-----------------|
| Ruff, MN |
| 14 |
| Ruff, MN Bye |
| Bye |

| |
|---------------------------|
| Switzer, VB |
| 16 |
| Maxwell, Mus Fall 0:00 |
| Maxwell, Mus |

ROUND 3

| |
|---------------------------------------|
| January, Jay |
| 17 |
| January, Jay TF-1.5 0:00 (16-1) |
| Noley, BMG |

| |
|-------------------------|
| Daily, Pot |
| 19 |
| Daily, Pot Fall 0:00 |
| Johnson, Jay |

| |
|-----------------------|
| Whittingto, Dur |
| 21 |
| Ruff, MN Fall 0:00 |
| Ruff, MN |

| |
|-------------------------|
| Kelly, McA |
| 23 |
| Kelly, McA Fall 0:00 |
| Switzer, VB |

| |
|------------------|
| Goff, Ard |
| 18 |
| Goff, Ard Bye |
| Bye |

| |
|--------------------|
| Riley, Unat |
| 20 |
| Riley, Unat Bye |
| Bye |

| |
|----------------------|
| Schildt, Unat |
| 22 |
| Schildt, Unat Bye |
| Bye |

| |
|-------------------------|
| Hardy, Gro |
| 24 |
| Hardy, Gro Fall 0:00 |
| Maxwell, Mus |

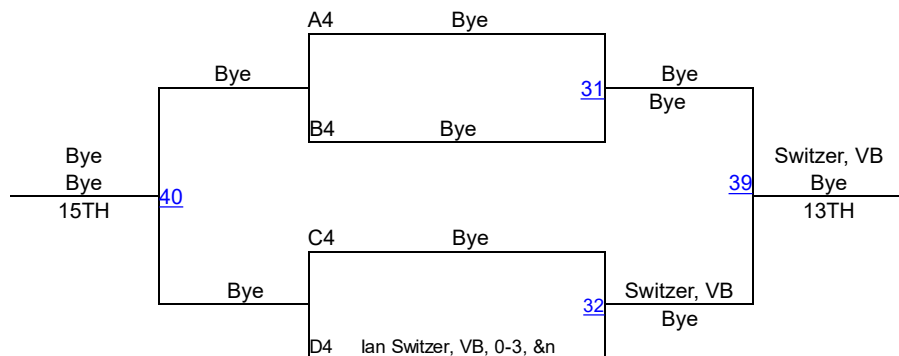
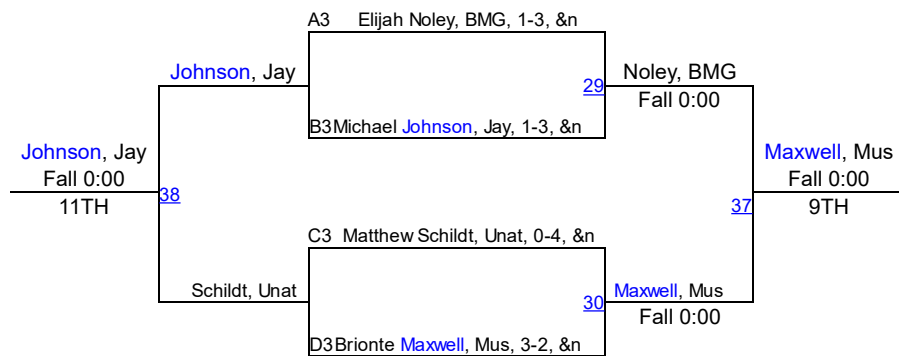
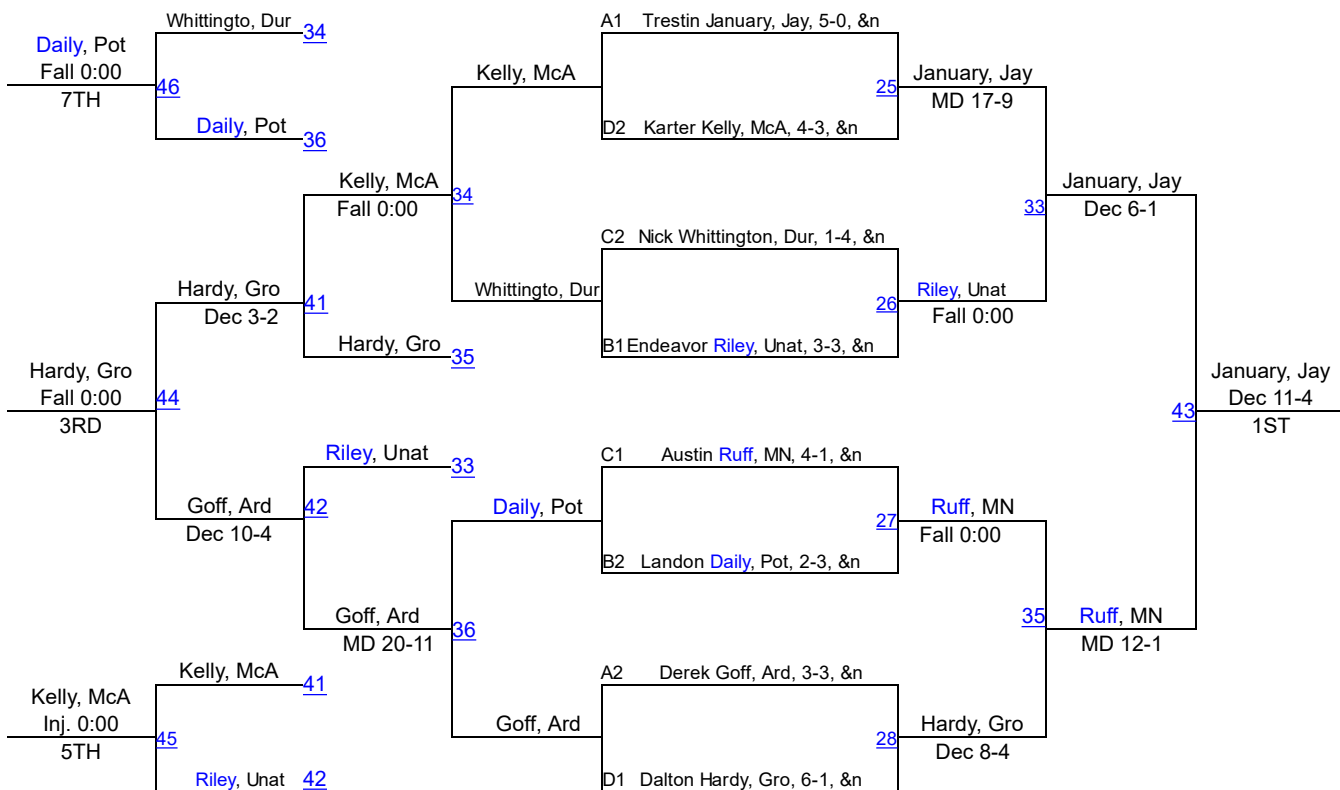

McAlester Invitational

145

| POOL A | | Round 1 | Round 2 | Round 3 | Round 4 | Round 5 |
|--------|--|---|---|--|---|---|
| 1 | Chase Hamilton MN, 2-6, &n | 2 / Bout 1 Hamilton, MN Fall 0:00 | 3 / Bout 7 Horner, Dur Dec 9-7 | 4 / Bout 13 Hamilton, MN Fall 0:00 | 5 / Bout 19 Hogan, Gro Fall 0:00 | 6 / Bout 25 Beets, Jay Fall 0:00 |
| 2 | Connor Wilkinson McA, 1-6, &n | 1 / Bout 1 Hamilton, MN Fall 0:00 | 5 / Bout 8 Hogan, Gro Fall 0:00 | 6 / Bout 14 Beets, Jay Fall 0:00 | 4 / Bout 20 Powell, Ada Fall 0:00 | 3 / Bout 26 Horner, Dur Fall 0:00 |
| 3 | Ethan Horner Dur, 5-4, &n | 4 / Bout 2 Powell, Ada Fall 0:00 | 1 / Bout 7 Horner, Dur Dec 9-7 | 5 / Bout 15 Hogan, Gro Fall 0:00 | 6 / Bout 21 Horner, Dur Dec 7-3 | 2 / Bout 26 Horner, Dur Fall 0:00 |
| 4 | Izaack Powell Ada, 3-4, &n | 3 / Bout 2 Powell, Ada Fall 0:00 | 6 / Bout 9 Beets, Jay Fall 0:00 | 1 / Bout 13 Hamilton, MN Fall 0:00 | 2 / Bout 20 Powell, Ada Fall 0:00 | 5 / Bout 27 Hogan, Gro Fall 0:00 |
| 5 | Houston Hogan Gro, 6-3, &n | 6 / Bout 3 Hogan, Gro Dec 7-3 | 2 / Bout 8 Hogan, Gro Fall 0:00 | 3 / Bout 15 Hogan, Gro Fall 0:00 | 1 / Bout 19 Hogan, Gro Fall 0:00 | 4 / Bout 27 Hogan, Gro Fall 0:00 |
| 6 | Jackson Beets Jay, 4-4, &n | 5 / Bout 3 Hogan, Gro Dec 7-3 | 4 / Bout 9 Beets, Jay Fall 0:00 | 2 / Bout 14 Beets, Jay Fall 0:00 | 3 / Bout 21 Horner, Dur Dec 7-3 | 1 / Bout 25 Beets, Jay Fall 0:00 |

| POOL B | | Round 1 | Round 2 | Round 3 | Round 4 | Round 5 |
|--------|---|--|---|---|---|---|
| 1 | Zach Carney VB, 3-4, &n | 2 / Bout 4 Tatum, Kin Fall 0:00 | 3 / Bout 10 Lilley, Pot Fall 0:00 | 4 / Bout 16 Carney, VB Fall 0:00 | 5 / Bout 22 Horton, Ard Fall 0:00 | 6 / Bout 28 Whitfield, Mus Dec 19-12 |
| 2 | Caleb Tatum Kin, 6-3, &n | 1 / Bout 4 Tatum, Kin Fall 0:00 | 5 / Bout 11 Horton, Ard Dec 1-0 | 6 / Bout 17 Tatum, Kin TF-1.5 0:00 (20-5) | 4 / Bout 23 Tatum, Kin Fall 0:00 | 3 / Bout 29 Lilley, Pot Dec 8-4 |
| 3 | Jarrett Lilley Pot, 7-1, &n | 4 / Bout 5 Lilley, Pot Fall 0:00 | 1 / Bout 10 Lilley, Pot Fall 0:00 | 5 / Bout 18 Lilley, Pot MD 15-5 | 6 / Bout 24 Lilley, Pot Fall 0:00 | 2 / Bout 29 Lilley, Pot Dec 8-4 |
| 4 | Chris Tran BMG, 0-7, &n | 3 / Bout 5 Lilley, Pot Fall 0:00 | 6 / Bout 12 Whitfield, Mus Fall 0:00 | 1 / Bout 16 Carney, VB Fall 0:00 | 2 / Bout 23 Tatum, Kin Fall 0:00 | 5 / Bout 30 Horton, Ard Fall 0:00 |
| 5 | Quintariou Horton Ard, 7-1, &n | 6 / Bout 6 Horton, Ard MD 18-10 | 2 / Bout 11 Horton, Ard Dec 1-0 | 3 / Bout 18 Lilley, Pot MD 15-5 | 1 / Bout 22 Horton, Ard Fall 0:00 | 4 / Bout 30 Horton, Ard Fall 0:00 |
| 6 | Miguel Whitfield Mus, 4-5, &n | 5 / Bout 6 Horton, Ard MD 18-10 | 4 / Bout 12 Whitfield, Mus Fall 0:00 | 2 / Bout 17 Tatum, Kin TF-1.5 0:00 (20-5) | 3 / Bout 24 Lilley, Pot Fall 0:00 | 1 / Bout 28 Whitfield, Mus Dec 19-12 |

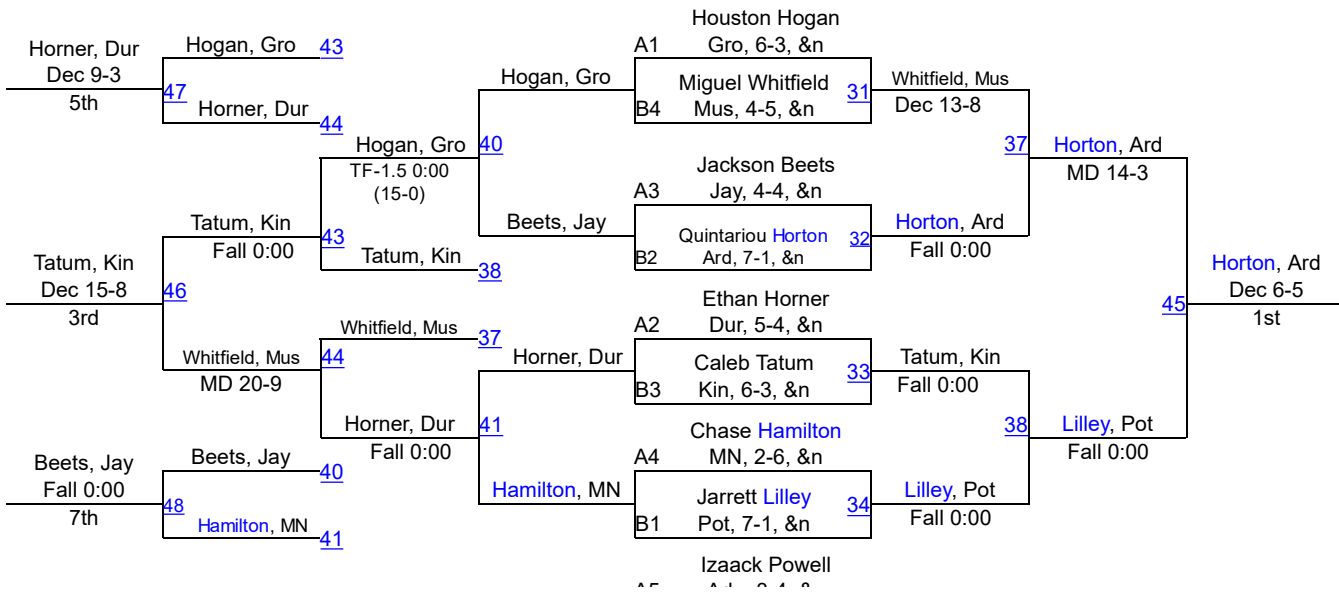

McAlester Invitational

152

Pool A

Pool B

Pool C

Pool D

ROUND 1

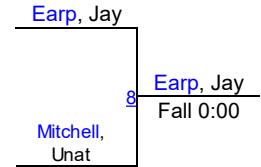
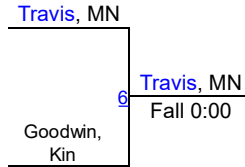
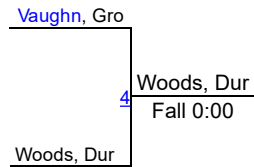
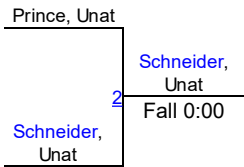
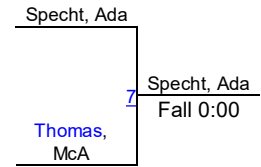
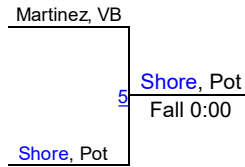
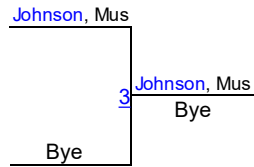
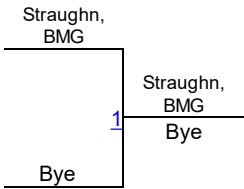

ROUND 2

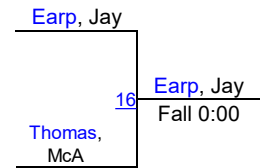
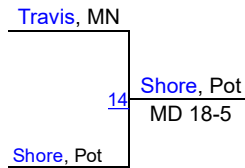
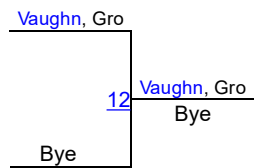
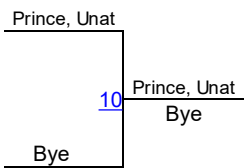
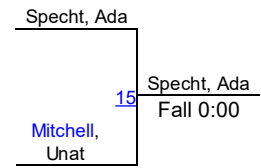
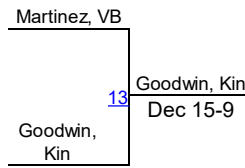
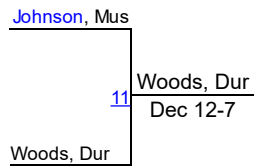
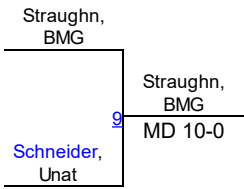

ROUND 3

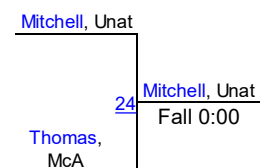
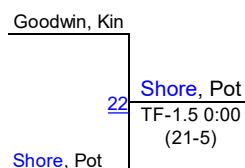
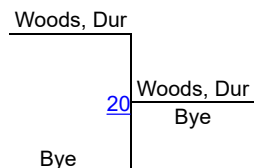
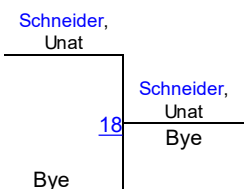
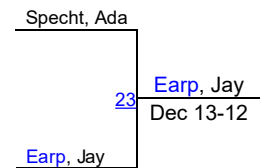
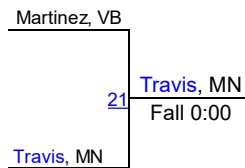
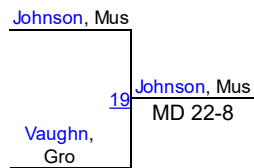
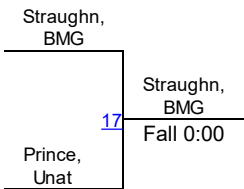

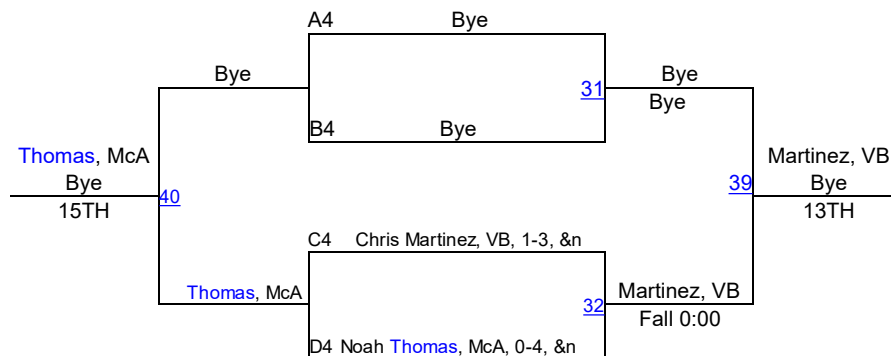
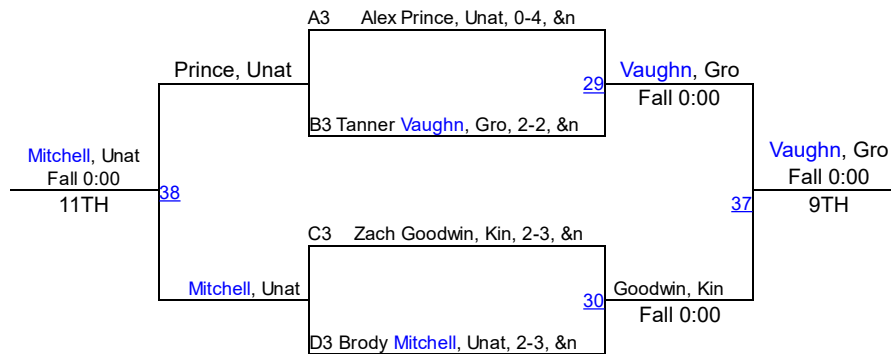
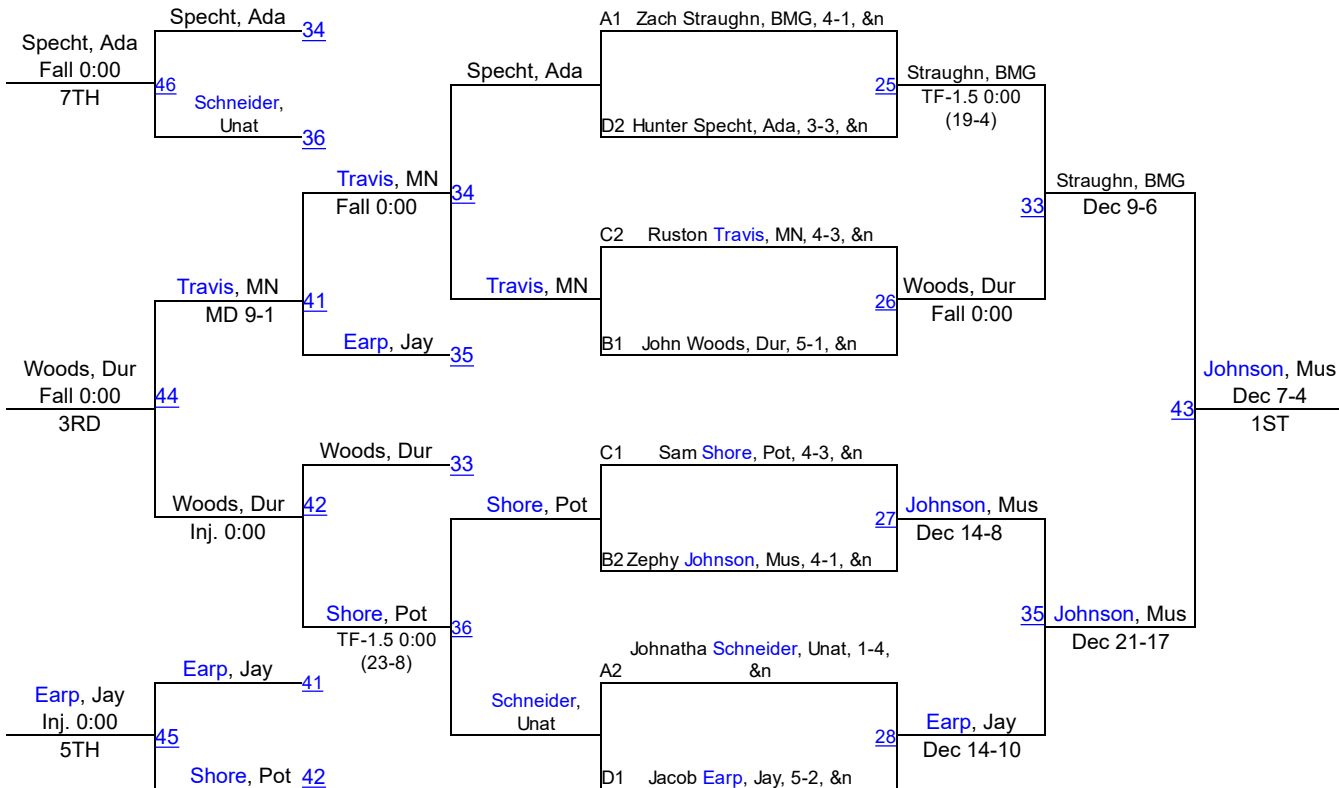

McAlester Invitational

160

| POOL A | | Round 1 | Round 2 | Round 3 | Round 4 | Round 5 |
|--------|-----------------------------------|--|---|--|--|---|
| 1 | Josh Countz McA, 7-2, &n | 2 /_ Bout 1 Countz, McA Fall 0:00 | 3 /_ Bout 7 Countz, McA Fall 0:00 | 4 /_ Bout 13 Countz, McA Fall 0:00 | 5 /_ Bout 19 Countz, McA Fall 0:00 | 6 /_ Bout 25 Countz, McA MD 9-1 |
| 2 | Dylan Swearingen Unat, 1-6, &n | 1 /_ Bout 1 Countz, McA Fall 0:00 | 5 /_ Bout 8 Cummings, Ard Fall 0:00 | 6 /_ Bout 14 Needham, VB Fall 0:00 | 4 /_ Bout 20 Ogden, Dur Fall 0:00 | 3 /_ Bout 26 Henderson, Gro Fall 0:00 |
| 3 | Dalton Henderson Gro, 2-6, &n | 4 /_ Bout 2 Henderson, Gro Fall 0:00 | 1 /_ Bout 7 Countz, McA Fall 0:00 | 5 /_ Bout 15 Cummings, Ard Fall 0:00 | 6 /_ Bout 21 Needham, VB Fall 0:00 | 2 /_ Bout 26 Henderson, Gro Fall 0:00 |
| 4 | Cade Ogden Dur, 2-5, &n | 3 /_ Bout 2 Henderson, Gro Fall 0:00 | 6 /_ Bout 9 Needham, VB Fall 0:00 | 1 /_ Bout 13 Countz, McA Fall 0:00 | 2 /_ Bout 20 Ogden, Dur Fall 0:00 | 5 /_ Bout 27 Cummings, Ard Fall 0:00 |
| 5 | Timmy Cummings Ard, 6-3, &n | 6 /_ Bout 3 Cummings, Ard Fall 0:00 | 2 /_ Bout 8 Cummings, Ard Fall 0:00 | 3 /_ Bout 15 Cummings, Ard Fall 0:00 | 1 /_ Bout 19 Countz, McA Fall 0:00 | 4 /_ Bout 27 Cummings, Ard Fall 0:00 |
| 6 | Alex Needham VB, 4-4, &n | 5 /_ Bout 3 Cummings, Ard Fall 0:00 | 4 /_ Bout 9 Needham, VB Fall 0:00 | 2 /_ Bout 14 Needham, VB Fall 0:00 | 3 /_ Bout 21 Needham, VB Fall 0:00 | 1 /_ Bout 25 Countz, McA MD 9-1 |

| POOL B | | Round 1 | Round 2 | Round 3 | Round 4 | Round 5 |
|--------|---------------------------------|--|---|---|---|---|
| 1 | Nathan Harris Mus, 3-6, &n | 2 /_ Bout 4 Johnson, Pot Fall 0:00 | 3 /_ Bout 10 Macdonald, Ada Fall 0:00 | 4 /_ Bout 16 Harris, Mus Fall 0:00 | 5 /_ Bout 22 Harris, Mus Fall 0:00 | 6 /_ Bout 28 Mendez, MN Fall 0:00 |
| 2 | Ross Johnson Pot, 6-3, &n | 1 /_ Bout 4 Johnson, Pot Fall 0:00 | 5 /_ Bout 11 Johnson, Pot Fall 0:00 | 6 /_ Bout 17 Mendez, MN Dec 6-0 | 4 /_ Bout 23 Johnson, Pot Fall 0:00 | 3 /_ Bout 29 Macdonald, Ada Dec 6-5 |
| 3 | Brody Macdonald Ada, 6-2, &n | 4 /_ Bout 5 Macdonald, Ada Fall 0:00 | 1 /_ Bout 10 Macdonald, Ada Fall 0:00 | 5 /_ Bout 18 Macdonald, Ada Fall 0:00 | 6 /_ Bout 24 Mendez, MN Fall 0:00 | 2 /_ Bout 29 Macdonald, Ada Dec 6-5 |
| 4 | Caleb Meeker Jay, 3-4, &n | 3 /_ Bout 5 Macdonald, Ada Fall 0:00 | 6 /_ Bout 12 Mendez, MN Fall 0:00 | 1 /_ Bout 16 Harris, Mus Fall 0:00 | 2 /_ Bout 23 Johnson, Pot Fall 0:00 | 5 /_ Bout 30 Meeker, Jay Fall 0:00 |
| 5 | Jacob McWhirter BMG, 0-7, &n | 6 /_ Bout 6 Mendez, MN Fall 0:00 | 2 /_ Bout 11 Johnson, Pot Fall 0:00 | 3 /_ Bout 18 Macdonald, Ada Fall 0:00 | 1 /_ Bout 22 Harris, Mus Fall 0:00 | 4 /_ Bout 30 Meeker, Jay Fall 0:00 |
| 6 | Christian Mendez MN, 8-0, &n | 5 /_ Bout 6 Mendez, MN Fall 0:00 | 4 /_ Bout 12 Mendez, MN Fall 0:00 | 2 /_ Bout 17 Mendez, MN Dec 6-0 | 3 /_ Bout 24 Mendez, MN Fall 0:00 | 1 /_ Bout 28 Mendez, MN Fall 0:00 |

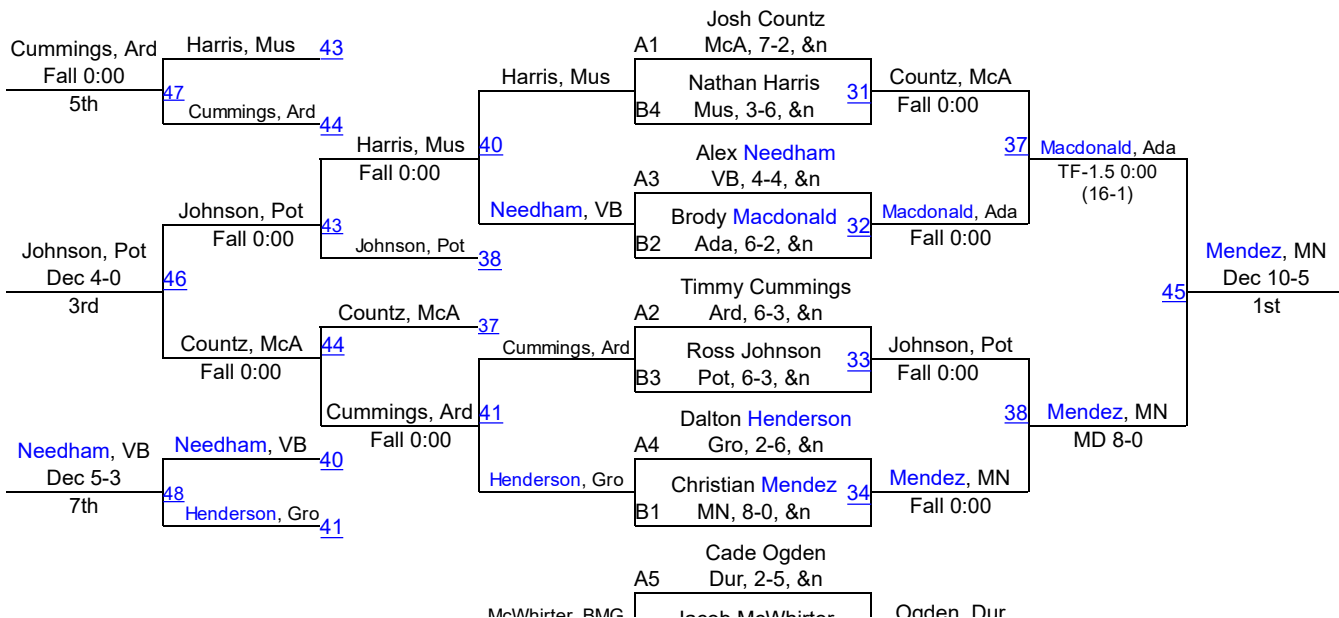

McAlester Invitational

170

| POOL A | | Round 1 | Round 2 | Round 3 | Round 4 | Round 5 |
|--------|---------------------------------|---|--|--|--|--|
| 1 | Miles Thomas MN, 4-4, &n | 2 /_ Bout 1 Thomas, MN Fall 0:00 | 3 /_ Bout 7 Rudolf, Dur Fall 0:00 | 4 /_ Bout 13 Thomas, MN MD 15-5 | 5 /_ Bout 19 Amos, Gro Fall 0:00 | 6 /_ Bout 25 Thomas, MN Fall 0:00 |
| 2 | Zaine Varnell Unat, 2-5, &n | 1 /_ Bout 1 Thomas, MN Fall 0:00 | 5 /_ Bout 8 Amos, Gro Fall 0:00 | 6 /_ Bout 14 Varnell, Unat Fall 0:00 | 4 /_ Bout 20 Novak, BMG Fall 0:00 | 3 /_ Bout 26 Rudolf, Dur Fall 0:00 |
| 3 | Brayden Rudolf Dur, 7-1, &n | 4 /_ Bout 2 Rudolf, Dur TF-1.5 0:00 (16-0) | 1 /_ Bout 7 Rudolf, Dur Fall 0:00 | 5 /_ Bout 15 Rudolf, Dur Fall 0:00 | 6 /_ Bout 21 Rudolf, Dur Fall 0:00 | 2 /_ Bout 26 Rudolf, Dur Fall 0:00 |
| 4 | PJ Novak BMG, 1-7, &n | 3 /_ Bout 2 Rudolf, Dur TF-1.5 0:00 (16-0) | 6 /_ Bout 9 Sixkiller, Jay Fall 0:00 | 1 /_ Bout 13 Thomas, MN MD 15-5 | 2 /_ Bout 20 Novak, BMG Fall 0:00 | 5 /_ Bout 27 Amos, Gro Dec 6-1 |
| 5 | Matt Amos Gro, 6-3, &n | 6 /_ Bout 3 Amos, Gro Fall 0:00 | 2 /_ Bout 8 Amos, Gro Fall 0:00 | 3 /_ Bout 15 Rudolf, Dur Fall 0:00 | 1 /_ Bout 19 Amos, Gro Fall 0:00 | 4 /_ Bout 27 Amos, Gro Dec 6-1 |
| 6 | Jacob Sixkiller Jay, 1-6, &n | 5 /_ Bout 3 Amos, Gro Fall 0:00 | 4 /_ Bout 9 Sixkiller, Jay Fall 0:00 | 2 /_ Bout 14 Varnell, Unat Fall 0:00 | 3 /_ Bout 21 Rudolf, Dur Fall 0:00 | 1 /_ Bout 25 Thomas, MN Fall 0:00 |

| POOL B | | Round 1 | Round 2 | Round 3 | Round 4 | Round 5 |
|--------|----------------------------------|--|--|---|---|---|
| 1 | Isaiah Bushnell Unat, 4-5, &n | 2 /_ Bout 4 Foley, Kin Fall 0:00 | 3 /_ Bout 10 Ulmer, Pot Fall 0:00 | 4 /_ Bout 16 Bushnell, Unat Fall 0:00 | 5 /_ Bout 22 Smead, McA Fall 0:00 | 6 /_ Bout 28 Bushnell, Unat Fall 0:00 |
| 2 | Chase Foley Kin, 7-2, &n | 1 /_ Bout 4 Foley, Kin Fall 0:00 | 5 /_ Bout 11 Foley, Kin Fall 0:00 | 6 /_ Bout 17 Foley, Kin Fall 0:00 | 4 /_ Bout 23 Foley, Kin Fall 0:00 | 3 /_ Bout 29 Ulmer, Pot Fall 0:00 |
| 3 | Nate Ulmer Pot, 8-0, &n | 4 /_ Bout 5 Ulmer, Pot Fall 0:00 | 1 /_ Bout 10 Ulmer, Pot Fall 0:00 | 5 /_ Bout 18 Ulmer, Pot Fall 0:00 | 6 /_ Bout 24 Ulmer, Pot Fall 0:00 | 2 /_ Bout 29 Ulmer, Pot Fall 0:00 |
| 4 | Tyson Going Ada, 1-6, &n | 3 /_ Bout 5 Ulmer, Pot Fall 0:00 | 6 /_ Bout 12 Thacker, VB Fall 0:00 | 1 /_ Bout 16 Bushnell, Unat Fall 0:00 | 2 /_ Bout 23 Foley, Kin Fall 0:00 | 5 /_ Bout 30 Smead, McA Fall 0:00 |
| 5 | Dakota Smead McA, 4-5, &n | 6 /_ Bout 6 Smead, McA Fall 0:00 | 2 /_ Bout 11 Foley, Kin Fall 0:00 | 3 /_ Bout 18 Ulmer, Pot Fall 0:00 | 1 /_ Bout 22 Smead, McA Fall 0:00 | 4 /_ Bout 30 Smead, McA Fall 0:00 |
| 6 | Tyler Thacker VB, 3-4, &n | 5 /_ Bout 6 Smead, McA Fall 0:00 | 4 /_ Bout 12 Thacker, VB Fall 0:00 | 2 /_ Bout 17 Foley, Kin Fall 0:00 | 3 /_ Bout 24 Ulmer, Pot Fall 0:00 | 1 /_ Bout 28 Bushnell, Unat Fall 0:00 |

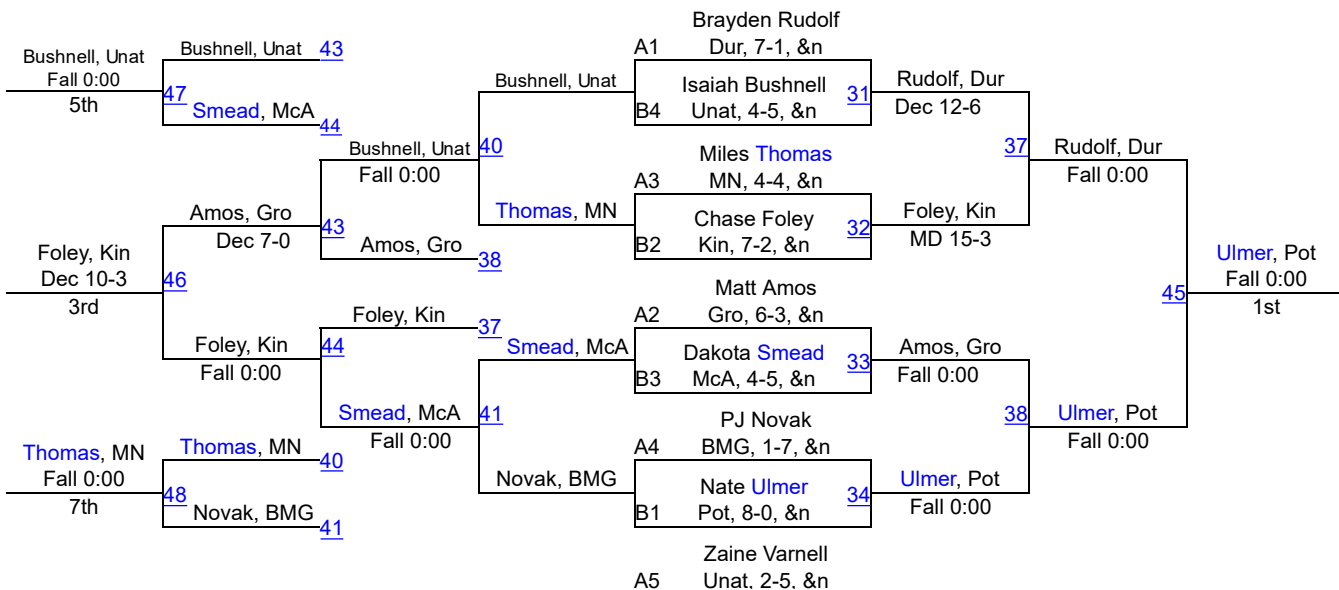

McAlester Invitational

182

Pool A

Pool B

Pool C

Pool D

ROUND 1

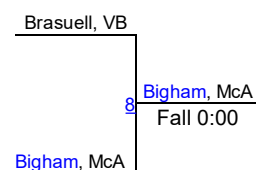
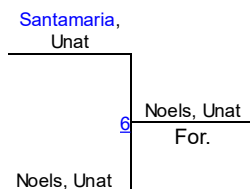
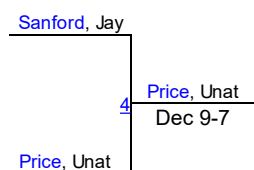
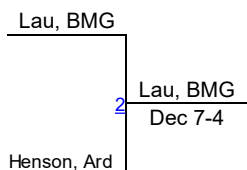
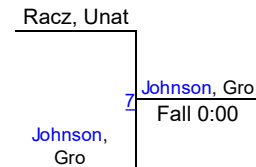
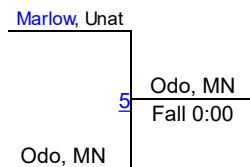
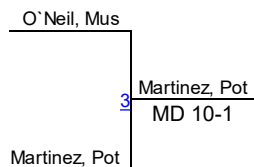
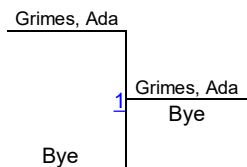

ROUND 2

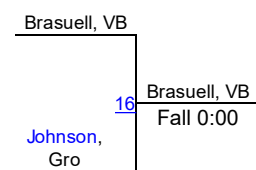
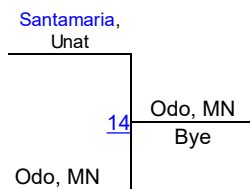
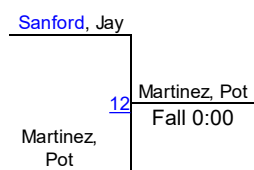
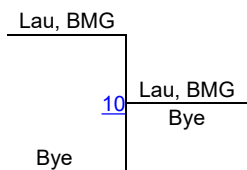
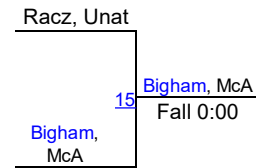
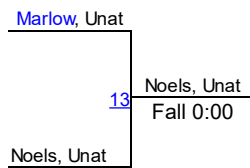
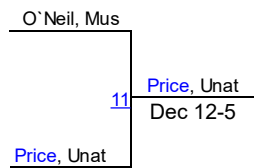
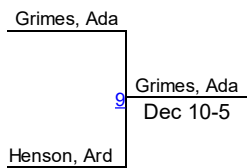

ROUND 3

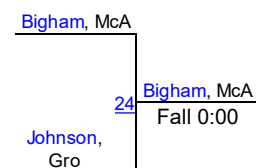
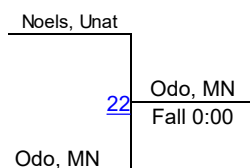
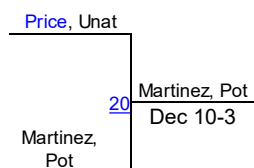
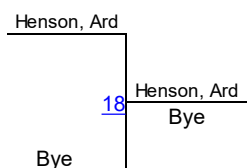
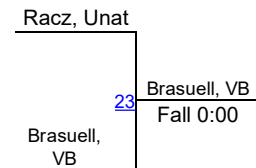
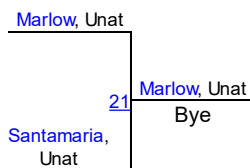
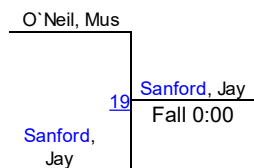
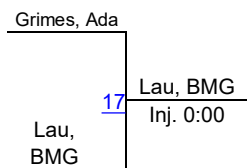

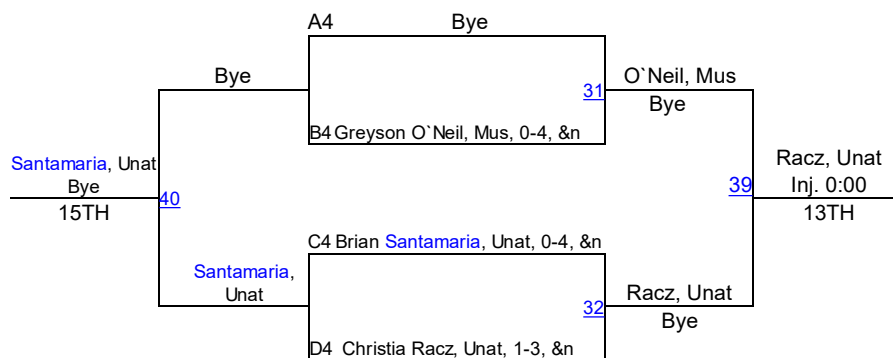
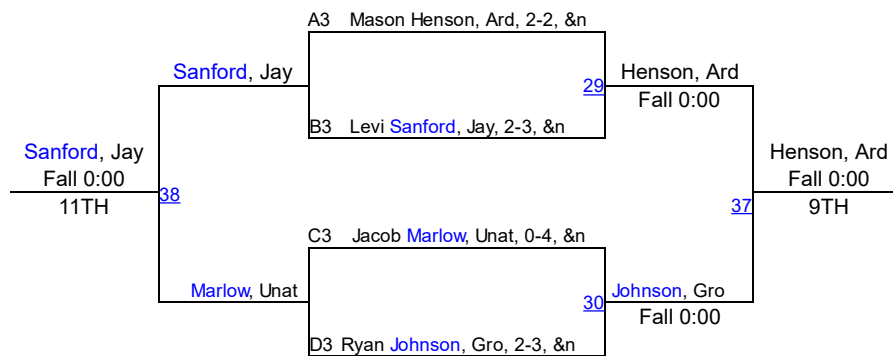
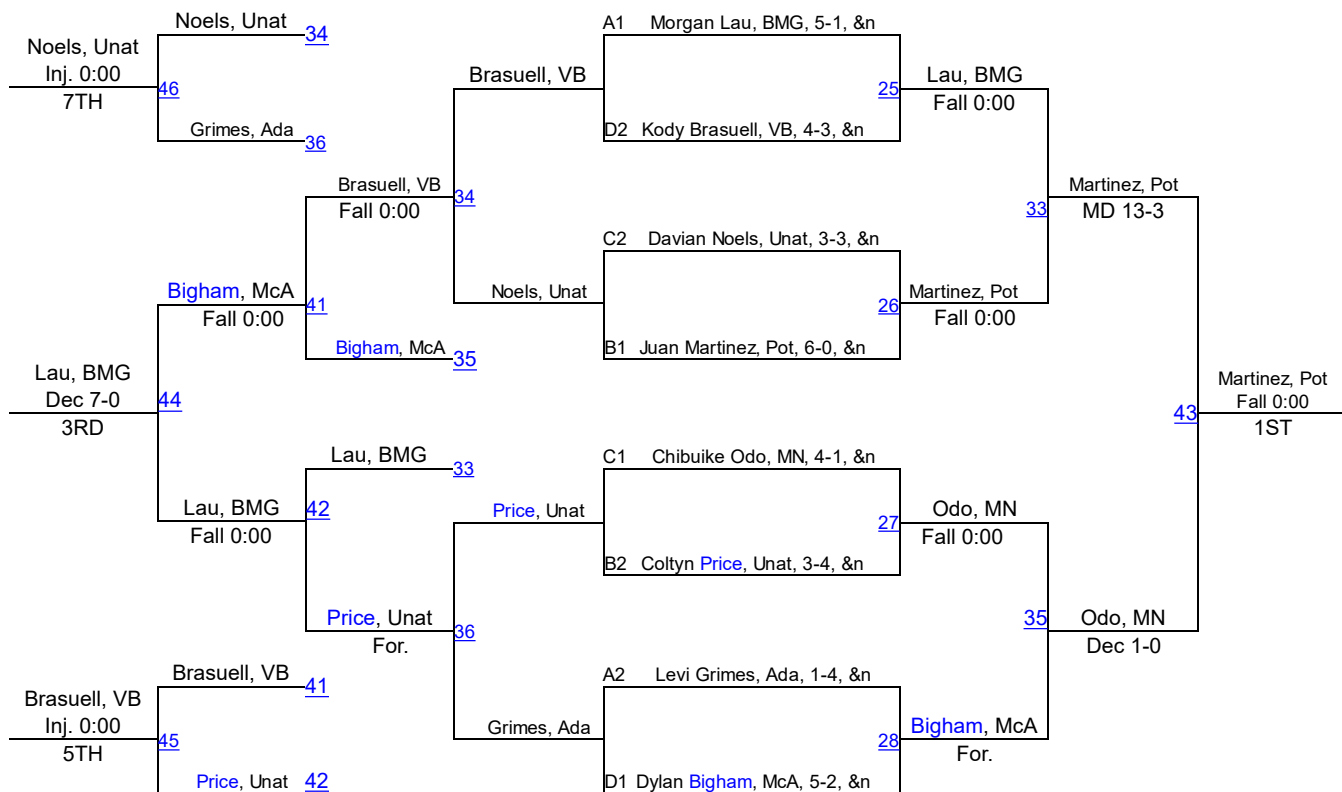

McAlester Invitational

220

Pool A

Pool B

Pool C

Pool D

ROUND 1

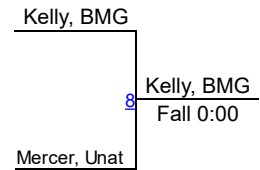
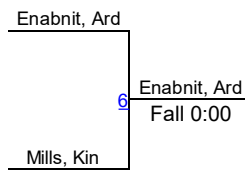
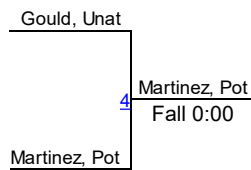
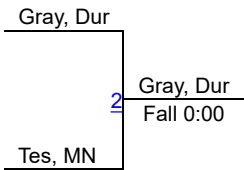
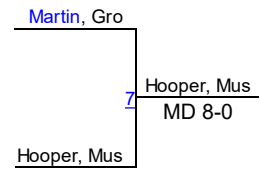
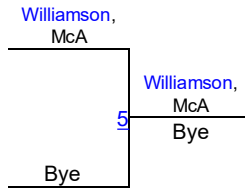
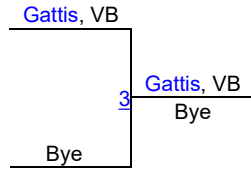
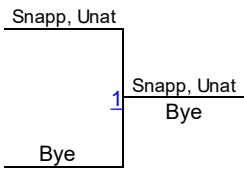

ROUND 2

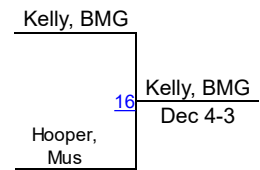
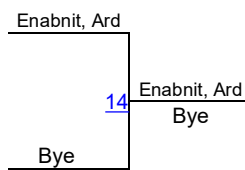
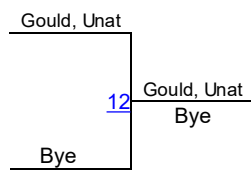
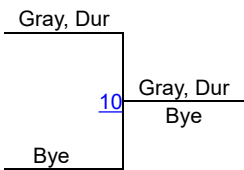
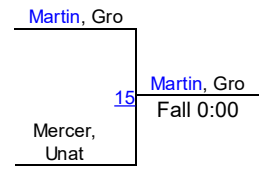
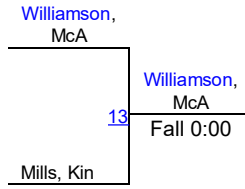
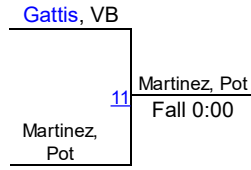
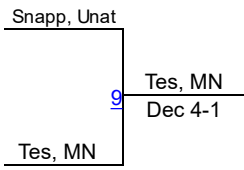

ROUND 3

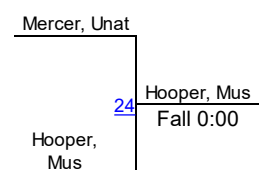
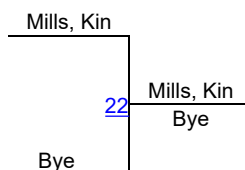
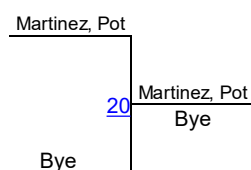
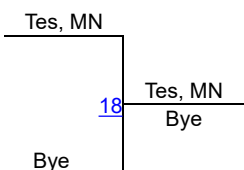
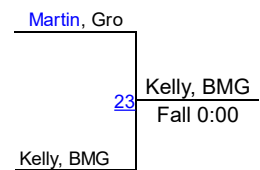
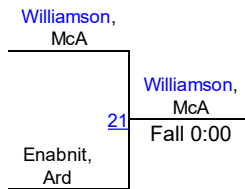
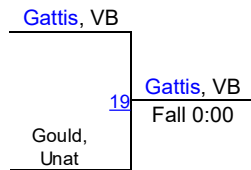
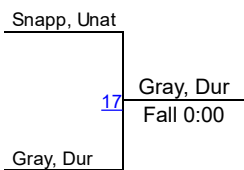

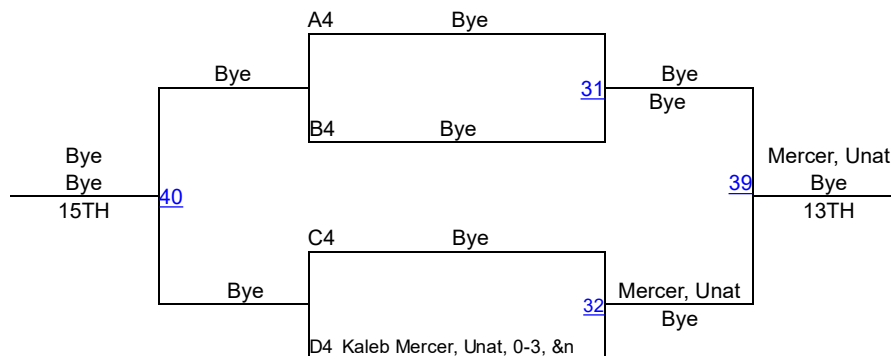
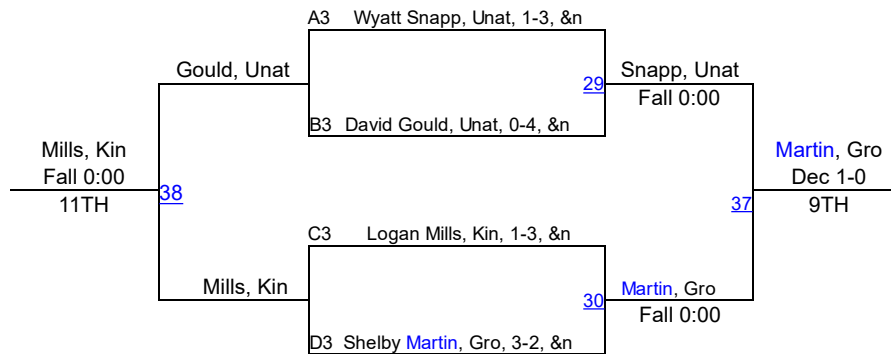
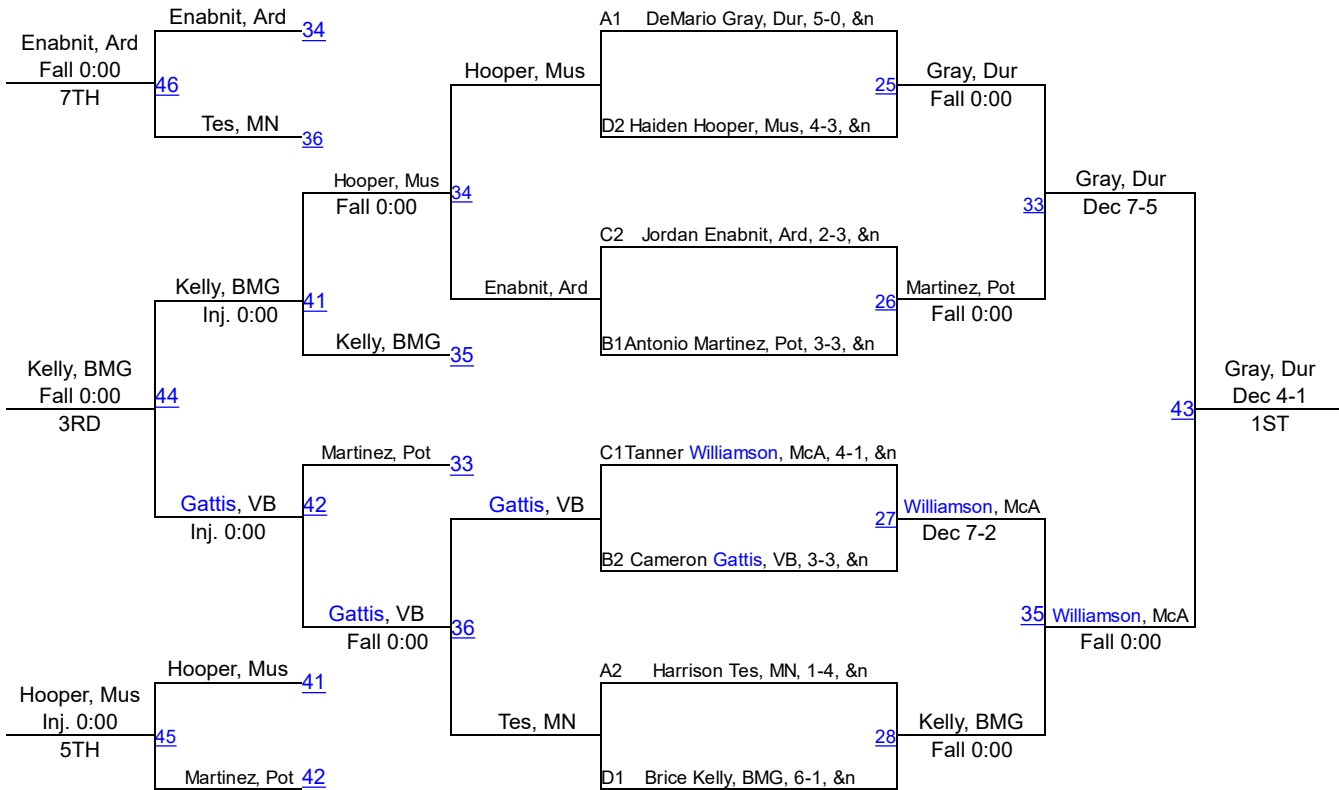

McAlester Invitational

285

Pool A

Pool B

Pool C

Pool D

ROUND 1

| |
|-----------------|
| Jackson, Tal |
| 1 Vineyard, Pot |
| Fall 0:00 |
| Vineyard, Pot |

| |
|----------------|
| Williams, Unat |
| 3 Benson, Ard |
| Fall 0:00 |
| Benson, Ard |

| |
|-------------|
| Wright, Mus |
| 5 Wann, Dur |
| Fall 0:00 |
| Wann, Dur |

| |
|----------------|
| Cook, Ada |
| 7 Cook, Ada |
| Fall 0:00 |
| Guerro-Cru, MN |

| |
|-----------------|
| Dry, Unat |
| 2 Connelly, BMG |
| Fall 0:00 |
| Connelly, BMG |

| |
|--------------|
| Ervin, Jay |
| 4 Ervin, Jay |
| Fall 0:00 |
| Johnson, VB |

| |
|----------------|
| McKay, McA |
| 6 Rudolf, Unat |
| Fall 0:00 |
| Rudolf, Unat |

| |
|----------------|
| Mendez, Unat |
| 8 Mendez, Unat |
| Fall 0:00 |
| Carter, Gro |

ROUND 2

| |
|-----------------|
| Jackson, Tal |
| 9 Connelly, BMG |
| Fall 0:00 |
| Connelly, BMG |

| |
|-------------------|
| Williams, Unat |
| 11 Williams, Unat |
| Fall 0:00 |
| Johnson, VB |

| |
|----------------|
| Wright, Mus |
| 13 Wright, Mus |
| Fall 0:00 |
| Rudolf, Unat |

| |
|--------------|
| Cook, Ada |
| 15 Cook, Ada |
| Fall 0:00 |
| Carter, Gro |

| |
|------------------|
| Dry, Unat |
| 10 Vineyard, Pot |
| Fall 0:00 |
| Vineyard, Pot |

| |
|----------------|
| Ervin, Jay |
| 12 Benson, Ard |
| Fall 0:00 |
| Benson, Ard |

| |
|--------------|
| McKay, McA |
| 14 Wann, Dur |
| Fall 0:00 |
| Wann, Dur |

| |
|-------------------|
| Mendez, Unat |
| 16 Guerro-Cru, MN |
| Fall 0:00 |
| Guerro-Cru, MN |

ROUND 3

| |
|--------------|
| Jackson, Tal |
| 17 Dry, Unat |
| Fall 0:00 |
| Dry, Unat |

| |
|----------------|
| Williams, Unat |
| 19 Ervin, Jay |
| Fall 0:00 |
| Ervin, Jay |

| |
|----------------|
| Wright, Mus |
| 21 Wright, Mus |
| Fall 0:00 |
| McKay, McA |

| |
|--------------|
| Cook, Ada |
| 23 Cook, Ada |
| Fall 0:00 |
| Mendez, Unat |

| |
|------------------|
| Connelly, BMG |
| 18 Connelly, BMG |
| Dec 8-6 |
| Vineyard, Pot |

| |
|----------------|
| Johnson, VB |
| 20 Benson, Ard |
| Fall 0:00 |
| Benson, Ard |

| |
|--------------|
| Rudolf, Unat |
| 22 Wann, Dur |
| Fall 0:00 |
| Wann, Dur |

| |
|-------------------|
| Carter, Gro |
| 24 Guerro-Cru, MN |
| Fall 0:00 |
| Guerro-Cru, MN |

